

SPRAY EQUIPMENT SINCE 1980
MACCHINE PER VERNICIATURA DAL 1980
PROUDLY MADE IN **ITALY**



2017
General Catalog



www.sinaer.eu

Download PDF >>





Index

Spray units	1
Road stripers	22
Pressure tanks	23
Spray guns	30
Paint hoses	34
Filters	38
Tips and nozzles	44
Suction pipes	45
Gravity hoppers	47
Taps	48
Nipples and fittings	50
Accessories	53
Spare parts	57



DISCLAIMER

Orders are accepted only under the following conditions :

PRICES: Ex Works, VAT excluded.

PACKING: to be carried at cost.

PAYMENTS: only anticipated payment is accepted (bank transfer, non-transferable check, PayPal, credit card).

SHIPPING: the goods always travel at the risk of the buyer even if sold carriage.

DELIVERY: orders are dispatched according to stock availability without warranty of balance. The terms of delivery mentioned in our offers are to be understood always subject to prior sale and however without any commitment.

REFUNDS: we do not accept returned goods without prior written permission.
Returned goods , whatever the reason, it must be made ex works Gualdo Cattaneo (PG) Italy

WARRANTY: we undertake to replace or credit (at our option) of the items may found to be defective, at our expense but we assume no liability for damages and costs any reason or cause.

COMPLAINTS: for any shortfall in quantity or defects must be received in writing within 8 days from the shipment date.

COSTS: occurring in the course of providing wage increases of raw materials or other related items production, we will apply the corresponding increase.

DISPUTE: for any dispute the jurisdiction is to Terni (Italy).

UPDATES: size and characteristics of the items described in this list are not binding and may be changed without notice. This price list supersedes all previous ones.

It is strictly forbidden to reproduce this price list in any form without written permission of MEDIA SPRAY srl.

All rights reserved.

*** **

RELEASE: _____

MM 101



Single diaphragm air-powered sprayer for low pressure

TECHNICAL FEATURES:

Flow rate: 10 lt./min.

Max. pressure: 7 bar

Compression ratio: 1:1



BASIC ACCESSORIES KIT:

- Spray gun M71
- Low-pressure coupled paint hose 10 mt.
- Suction and recycle system

Code: MM101

DM 2000 S



Double diaphragm air-powered sprayer for low pressure

TECHNICAL FEATURES:

Flow rate: 25 lt./min.

Max. pressure: 7 bar

Compression ratio: 1:1

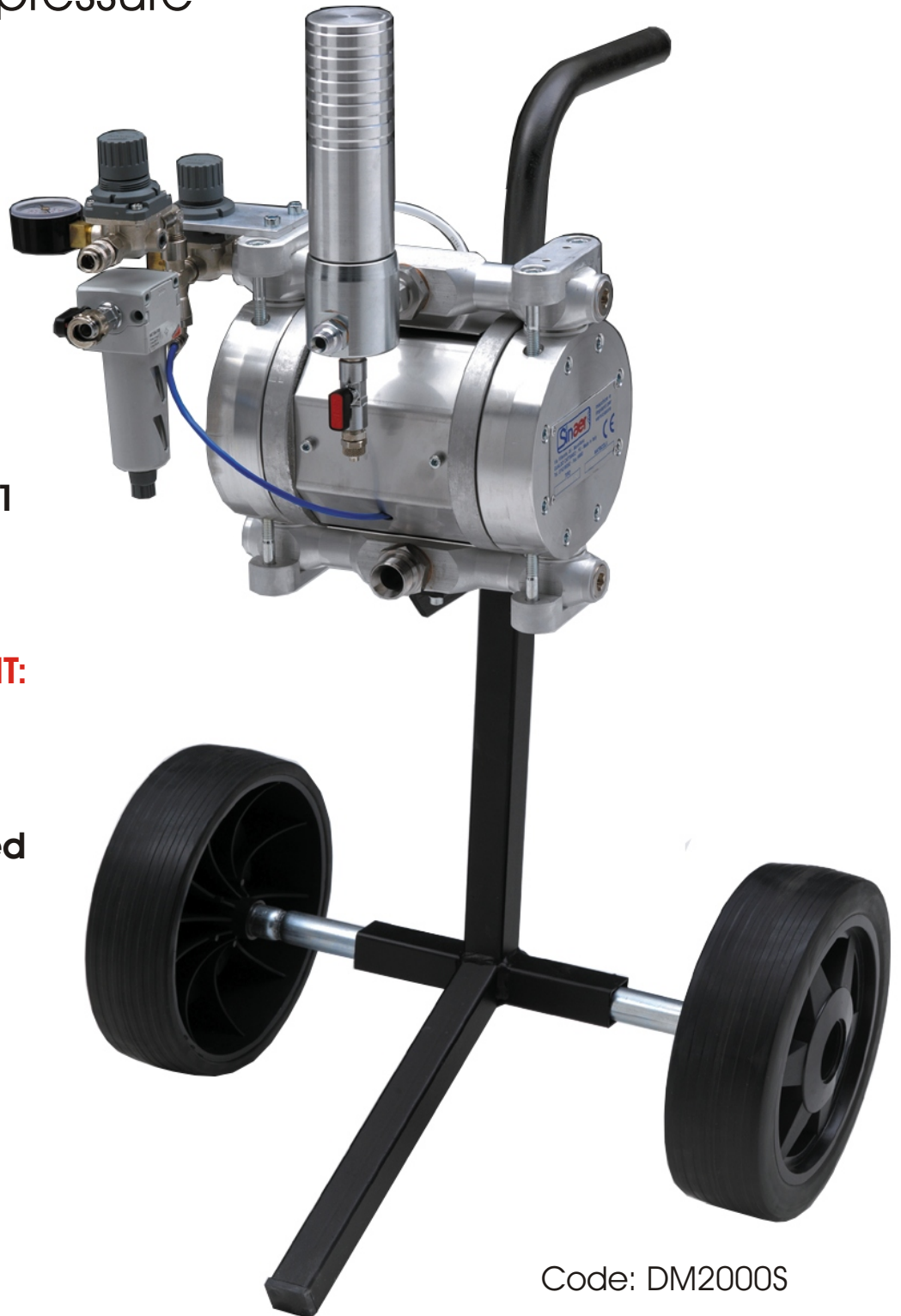

BASIC ACCESSORIES KIT:

- Spray gun M71
- Low-pressure coupled paint hose 10 mt.
- Suction and recycle system

Code: DM2000S

S 12:1 TN



Piston pneumatic sprayer
for high pressure
*(available for both airless
and air-assisted settings)*

TECHNICAL FEATURES:

Flow rate: 8 lt./min.

Max. pressure: 84 bar

Compression ratio: 12:1

BASIC ACCESSORIES KIT:

- Spray gun KS25 with tip and guard
- Airless paint hose 1/4" 10 mt.
- Suction and recycle system



Code: S121TN

S 12:1 TS

Piston pneumatic sprayer
for high pressure
*(available for both airless
and air-assisted settings)*



TECHNICAL FEATURES:

Flow rate: 15 lt./min.

Max. pressure: 84 bar

Compression ratio: 12:1

BASIC ACCESSORIES KIT:

- Spray gun KS25 with tip and guard
- Airless paint hose 1/4" 10 mt.
- Suction and recycle system



Code: S121TS

S 20:1 TN

Piston pneumatic sprayer
for high pressure
*(available for both airless
and air-assisted settings)*



TECHNICAL FEATURES:

Flow rate: 8 lt./min.

Max. pressure: 140 bar

Compression ratio: 20:1

BASIC ACCESSORIES KIT:

- Spray gun KS25 with tip and guard
- Airless paint hose 1/4" 10 mt.
- Suction and recycle system



Code: S201TN

S 20:1 TS

Piston pneumatic sprayer
for high pressure
*(available for both airless
and air-assisted settings)*



TECHNICAL FEATURES:

Flow rate: 15 lt./min.

Max. pressure: 140 bar

Compression ratio: 20:1

BASIC ACCESSORIES KIT:

- Spray gun KS25 with tip and guard
- Airless paint hose 1/4" 10 mt.
- Suction and recycle system



Code: S201TS

S 30:1 TX



Piston pneumatic sprayer
for high pressure
*(available for both airless
and air-assisted settings)*

TECHNICAL FEATURES:

Flow rate: 3,5 lt./min.

Max. pressure: 210 bar

Compression ratio: 30:1

BASIC ACCESSORIES KIT:

- Spray gun KS25 with tip and guard
- Airless paint hose 1/4" 10 mt.
- Suction and recycle system



Code: S301TX

S 32:1 TN



Piston pneumatic sprayer
for high pressure
*(available for both airless
and air-assisted settings)*

TECHNICAL FEATURES:

Flow rate: 8 lt./min.

Max. pressure: 224 bar

Compression ratio: 32:1

BASIC ACCESSORIES KIT:

- Spray gun KS25 with tip and guard
- Airless paint hose 1/4" 10 mt.
- Suction and recycle system



Code: S321TN

S 32:1 TS



Piston pneumatic sprayer
for high pressure
*(available for both airless
and air-assisted settings)*

TECHNICAL FEATURES:

Flow rate: 15 lt./min.

Max. pressure: 224 bar

Compression ratio: 32:1

BASIC ACCESSORIES KIT:

- Spray gun KS25 with tip and guard
- Airless paint hose 1/4" 10 mt.
- Suction and recycle system



Code: S321TS

S 50:1 TN



Piston pneumatic sprayer
for high pressure
*(available for both airless
and air-assisted settings)*

TECHNICAL FEATURES:

Flow rate: 8 lt./min.

Max. pressure: 350 bar

Compression ratio: 50:1

BASIC ACCESSORIES KIT:

- Spray gun KS25 with tip and guard
- Airless paint hose 1/4" 10 mt.
- Suction and recycle system



Code: S501TN

NEW 4500



Airless diaphragm sprayer
with electric motor

TECHNICAL FEATURES:

Flow rate: 4 lt./min.

Max pressure: 200 bar

Motor power: 1,1 kW
monofasic

Max nozzle size: 0,023"

BASIC ACCESSORIES KIT:

- Spray gun KS25 with tip and guard
- Airless paint hose 1/4" 10 mt.
- Suction and recycle system



Code: NEW4500

EXPORT 7000



Airless diaphragm sprayer
with electric motor

TECHNICAL FEATURES:

Flow rate: 5,5 lt./min.

Max pressure: 230 bar

Motor power: 1,5 kW
monofasic

Max nozzle size: 0,031"

BASIC ACCESSORIES KIT:

- Spray gun KS25 with tip and guard
- Airless paint hose 1/4" 10 mt.
- Suction and recycle system



Code: EXP7000

EXPORT 10000



Airless diaphragm sprayer
with electric motor

TECHNICAL FEATURES:

Flow rate: 7 lt./min.

Max pressure: 250 bar

Motor power: 2,2 kW
monofasic

Max nozzle size: 0,036"

BASIC ACCESSORIES KIT:

- Spray gun KS25 with tip and guard
- Airless paint hose 1/4" 10 mt.
- Suction and recycle system



Code: EXP10000

SC 4500



Airless diaphragm sprayer
with petrol engine

TECHNICAL FEATURES:

Flow rate: 4 lt./min.

Max. pressure: 200 bar

Motor: petrol engine HP
4.0 - 1420 RPM

Max. nozzle size: 0,023"

BASIC ACCESSORIES KIT:

- Airless spray gun Ks25
with tip and guard
- Airless paint hose 1/4"
10 mt.
- Suction and recycle
system



Code: SC4500

SC 7000



Airless diaphragm sprayer
with petrol engine

TECHNICAL FEATURES:

Flow rate: 5,5 lt./min.

Max. pressure: 230 bar

Motor: petrol engine HP
5.5 - 1420 RPM

Max. nozzle size: 0,031"

BASIC ACCESSORIES KIT:

- Airless spray gun KS25
with tip and guard
- Airless paint hose 1/4"
10 mt.
- Suction and recycle
system



Code: SC7000

SC 10000



Airless diaphragm sprayer
with petrol engine

TECHNICAL FEATURES:

Flow rate: 7 lt./min.

Max. pressure: 250 bar

Motor: petrol engine HP
5.5 - 1420 RPM

Max. nozzle size: 0,036"

BASIC ACCESSORIES KIT:

- Airless spray gun KS25
with tip and guard
- Airless paint hose 1/4"
10 mt.
- Suction and recycle
system



Code: SC10000



SPRAY FORCE ONE 3.1-E

Hydraulic airless piston sprayer



TECHNICAL FEATURES:

Flow rate: 3,1 lt./min.

Max pressure: 230 bar

Motor: electric
monofasic 1,5 kW /
petrol engine HP4.0 -
1420 RPM

Max nozzle size:
0,031"*

(* with stucco or other high-density products)

BASIC ACCESSORIES KIT:

- Spray gun GR11 with tip and guard
- Airless paint hose 3/8" 10 mt.
- Inline fluid filter for high pressure



Code: SF131E



SPRAY FORCE ONE 5.5-E

Hydraulic airless piston sprayer



TECHNICAL FEATURES:

Flow rate: 5,5 lt./min.

Max pressure: 230 bar

Motor: electric
monofasic 2,2 kW

Max nozzle size:
0,043"*

(* with stucco or other high-density products)

BASIC ACCESSORIES KIT:

- Spray gun GR11 with tip and guard
- Airless paint hose 3/8" 10 mt.
- Inline fluid filter for high pressure



Code: SF155E



SPRAY FORCE ONE 8.9-E

Hydraulic airless piston sprayer



TECHNICAL FEATURES:

Flow rate: 8,9 lt./min.

Max pressure: 230 bar

Motor: electric
monofasic 5,0 kW

Max nozzle size:
0,052"*

(* with stucco or other high-density products)

BASIC ACCESSORIES KIT:

- Spray gun GR11 with tip and guard
- Airless paint hose 3/8" 10 mt.
- Inline fluid filter for high pressure



Code: SF189E

DB 2000 MIX



Air-assisted diaphragm pump
for spraying bi-component
products in low pressure

TECHNICAL FEATURES:

Flow rate of "A" and B"
pumps: 12,5 + 12,5
lt./min.

Flow rate of washing
pump: 10 lt./min.

Max. pressure: 7 bar

Compression ratio: 1:1

Mixing ratio: 1:1



BASIC ACCESSORIES KIT:

- Spray gun
M71
- Coupled hose
for low pressure
10 mt.
- Suction and
recycle system

Code: DB2000MIX

D 25:1 BC

Air-assisted piston pump for spraying bi-component products in high pressure

TECHNICAL FEATURES:

Flow rate of "A" and "B" pumps: 8+8 lt./min.

Max. pressure: 175 bar

Compression ratio: 25:1

Mixing ratio: 1:1



KIT ACCESSORI DI BASE:

- Washing pump
- Static mixer
- Metal wire airless paint hose 1/4" 10 mt. (n.2 units)
- Airless spray gun for bi-component products
- Suction and recycle system (n.3 units)

Code: D251BC

TR 4500 P/E



Airless roadmarker

Semi-automatic road striper based on the airless diaphragm sprayer SINAER mod. SC 4500 (4.5 lt./min, max. pressure 220 bar, max nozzle size 0.21, gas engine 4.0 HP reduced at 1400 RPM) or mod. NEW 4500 (4.5 lt./min, max. pressure 220 bar, max nozzle size 0.023", electric motor 1.1 kW - 1.400 rpm) on pivoting rear axle trolley, equipped with suction and recycling system, SK90 airless spray gun with 20-cm extension pole, self-cleaning tip nozzle and nozzle guard, pressure gauge and compensator.



Code: TR4500E (electric)
TR4500P (gas)

Pressure tanks

Picture

Code

Description



SSP02SS



UPT 2 X - 2 lt. pressure tank.



SSP10SS

UPT 10 X - 10 lt. pressure tank without stirrer. Pressure control product, idlers, upper product output. TUV certified.

Pressure tanks

Picture	Code	Description
	SSP10SI	UPT 10 Y - 10 lt. pressure tank without stirrer. Pressure control product, idlers, lower product output. TUV certified.
	SSP10PS	UPT 10 PX - 10 lt. pressure tank with pneumatic stirrer. Pressure control product, idlers, upper product output. TUV certified.

Pressure tanks

Picture

Code

Description



SSP10PI

UPT 10 PY - 10 lt. pressure tank with pneumatic stirrer. Pressure control product, idlers, lower product output. TUV certified.



SSP20SS

UPT 20 X - 20 lt. pressure tank without stirrer. Pressure control product, idlers, upper product output. TUV certified.

Pressure tanks

Picture	Code	Description
	SSP20SI	UPT 20 Y - 20 lt. pressure tank without stirrer. Pressure control product, idlers, lower product output. TUV certified.
	SSP20MS	UPT 20 HX - 20 lt. pressure tank with manual stirrer. Pressure control product, idlers, upper product output. TUV certified.

Pressure tanks

Picture

Code

Description



SSP20MI

UPT 20 PX - 20 lt. pressure tank with pneumatic stirrer. Pressure control product, idlers, upper product output. TUV certified.



SSP20PS

UPT 20 PX - 20 lt. pressure tank with pneumatic stirrer. Pressure control product, idlers, upper product output. TUV certified.

Pressure tanks

Picture	Code	Description
	SSP20PI	UPT 20 PY - 20 lt. pressure tank with pneumatic stirrer. Pressure control product, idlers, lower product output. TUV certified.
	SSP40MS	UPT 40 HX - 40 lt. pressure tank with manual stirrer. Pressure control product, idlers, upper product output. TUV certified.



Pressure tanks

Picture

Code

Description



SSP40PS





UPT 40 PX - 40 lt. pressure tank with pneumatic stirrer. Pressure control product, idlers, upper product output. TUV certified.



Spray guns

Picture	Code	Description
	A1227021	KS 25 - Airless spray gun (max. 250 BAR) - connection 7/8"
	A1227159	SK 90 - Airless spray gun (max. 500 bar) - connection 1 1/16"
	A1227160	GR 11 - Airless spray gun (max. 350 BAR) - connection 7/8"
	A1227029	GR 13 - Airless spray gun (max. 510 BAR) - connection 7/8"

Spray guns

Picture	Code	Description
	A1227099W	BW 39 - Javelin airless spray gun (max. 250 BAR) - connection 7/8"
	A1227001	M 71 - Air-assisted spray gun for low pressure (max. 7 bar). Available nozzles 0.8, 1.0, 1.2, 1.3, 1.5, 1.8
	A1227007	M 77 - Air-assisted spray gun for low pressure (max. 7 bar). Available nozzles 1.2, 1.5, 2.0, 2.5
	A1227100	M 100 - Air-assisted spray gun for low pressure (max. 7 bar). Available nozzles 1.0, 1.3, 1.8, 2.0



Spray guns

Picture	Code	Description
	A1227108	K 591 air-assisted HVLP spray gun. Available nozzles: 1.0, 1.4, 1.6, 2.0
	A1609ZVX	MK MIX -air assisted spray gun for high pressure - MADE IN SPAIN - TOP QUALITY PRODUCT
	A1097108	OPTIMA 2000 air assisted spray gun for high pressure (max. 250 bar) - MADE IN GERMANY - TOP QUALITY PRODUCT

Spray guns

Picture	Code	Description
	BCG01X	SK 200 BI - Airless spray gun for bicomponent products (max. 250 bar) with mixer
	AUT101X	YDA-101 automatic air-assisted spray gun. Air consumption 270 lt./min., pattern width 230 mm, working pressure 3-4 bar. Available nozzles: 0.8, 1.0, 1.3, 1.5, 1.8, 2.0.
	AUT200X	YDA-200 automatic air-assisted spray gun. Air consumption 530 lt./min., pattern width 400 mm, working pressure 3-4 bar. Available nozzles: 1.2, 1.4, 1.5, 1.6, 1.8, 2.0, 2.5.
	A1227024A	AP 81 - Automatic airless spray gun (max. 250 bar)



Paint hoses

Available fittings: 1/4" - 16x1,5 - 3/8"

Picture	Code	Description
	PHTX31675	Textile-braid 3/16" high pressure airless paint hose 7,5 meters, max. pressure 230 bar
	PHTX31610	Textile-braid 3/16" high pressure airless paint hose 10 meters, max. pressure 230 bar
	PHTX31615	Textile-braid 3/16" high pressure airless paint hose 15 meters, max. pressure 230 bar
	PHTX31620	Textile-braid 3/16" high pressure airless paint hose 20 meters, max. pressure 230 bar
	PHTX1475	Textile-braid 1/4" high pressure airless paint hose 7,5 meters, max. pressure 230 bar
	PHTX1410	Textile-braid 1/4" high pressure airless paint hose 10 meters, max. pressure 230 bar
	PHTX1415	Textile-braid 1/4" high pressure airless paint hose 15 meters, max. pressure 230 bar
	PHTX1420	Textile-braid 1/4" high pressure airless paint hose 20 meters, max. pressure 230 bar
	PHTX3875	Textile-braid 3/8" high pressure airless paint hose 7,5 meters, max. pressure 230 bar
	PHTX3810	Textile-braid 3/8" high pressure airless paint hose 10 meters, max. pressure 230 bar
	PHTX3815	Textile-braid 3/8" high pressure airless paint hose 15 meters, max. pressure 230 bar
	PHTX3820	Textile-braid 3/8" high pressure airless paint hose 20 meters, max. pressure 230 bar



Paint hoses



Available fittings: 1/4" - 16x1,5 - 3/8"

Picture	Code	Description
	PHMB31675	Metal-braid 3/16" high pressure airless paint hose 7,5 meters, max. pressure 300 bar
	PHMB31610	Metal-braid 3/16" high pressure airless paint hose 10 meters, max. pressure 300 bar
	PHMB31615	Metal-braid 3/16" high pressure airless paint hose 15 meters, max. pressure 300 bar
	PHMB31620	Metal-braid 3/16" high pressure airless paint hose 20 meters, max. pressure 300 bar
	PHMB1475	Metal-braid 1/4" high pressure airless paint hose 7,5 meters, max. pressure 300 bar
	PHMB1410	Metal-braid 1/4" high pressure airless paint hose 10 meters, max. pressure 300 bar
	PHMB1415	Metal-braid 1/4" high pressure airless paint hose 15 meters, max. pressure 300 bar
	PHMB1420	Metal-braid 1/4" high pressure airless paint hose 20 meters, max. pressure 300 bar
	PHMB3875	Metal-braid 3/8" high pressure airless paint hose 7,5 meters, max. pressure 225 bar
	PHMB3810	Metal-braid 3/8" high pressure airless paint hose 10 meters, max. pressure 225 bar
	PHMB3815	Metal-braid 3/8" high pressure airless paint hose 15 meters, max. pressure 225 bar
	PHMB3820	Metal-braid 3/8" high pressure airless paint hose 20 meters, max. pressure 225 bar



Paint hoses

Available fittings: 1/4" - 16x1,5 - 3/8"

Picture	Code	Description
	PH2A31675	Coupled metal-braid 3/16" high pressure airless paint hose 7,5 meters, max. pressure 300 bar
	PH2A31610	Coupled metal-braid 3/16" high pressure airless paint hose 10 meters, max. pressure 300 bar
	PH2A31615	Coupled metal-braid 3/16" high pressure airless paint hose 15 meters, max. pressure 300 bar
	PH2A31620	Coupled metal-braid 3/16" high pressure airless paint hose 20 meters, max. pressure 300 bar
	PH2A1475	Coupled metal-braid 1/4" high pressure airless paint hose 7,5 meters, max. pressure 300 bar
	PH2A1410	Coupled metal-braid 1/4" high pressure airless paint hose 10 meters, max. pressure 300 bar
	PH2A1415	Coupled metal-braid 1/4" high pressure airless paint hose 15 meters, max. pressure 300 bar
	PH2A1420	Coupled metal-braid 1/4" high pressure airless paint hose 20 meters, max. pressure 300 bar
	PH2A3875	Coupled metal-braid 3/8" high pressure airless paint hose 7,5 meters, max. pressure 225 bar
	PH2A3810	Coupled metal-braid 3/8" high pressure airless paint hose 10 meters, max. pressure 225 bar
	PH2A3815	Coupled metal-braid 3/8" high pressure airless paint hose 15 meters, max. pressure 225 bar
	PH2A3820	Coupled metal-braid 3/8" high pressure airless paint hose 20 meters, max. pressure 225 bar







Paint hoses

Available fittings: 1/4" - 16x1,5 - 3/8"

Picture	Code	Description	
	TBP867514	Coupled PE/PA paint hose for low pressure, int. 6 mm, ext. 8 mm, lenght 7,5 mt., fitting 1/4"	
	TBP861014	Coupled PE/PA paint hose for low pressure, int. 6 mm, ext. 8 mm, lenght 10 mt., fitting 1/4"	
	TBP861514	Coupled PE/PA paint hose for low pressure, int. 6 mm, ext. 8 mm, lenght 15 mt., fitting 1/4"	
	TBP862014	Coupled PE/PA paint hose for low pressure, int. 6 mm, ext. 8 mm, lenght 20 mt., fitting 1/4"	
	TBP867516	Coupled PE/PA paint hose for low pressure, int. 6 mm, ext. 8 mm, lenght 7,5 mt., fitting 16x1,5	
	TBP861016	Coupled PE/PA paint hose for low pressure, int. 6 mm, ext. 8 mm, lenght 10 mt., fitting 16x1,5	
	TBP861516	Coupled PE/PA paint hose for low pressure, int. 6 mm, ext. 8 mm, lenght 15 mt., fitting 16x1,5	
	TBP862016	Coupled PE/PA paint hose for low pressure, int. 6 mm, ext. 8 mm, lenght 20 mt., fitting 16x1,5	
		TBP867538	Coupled PE/PA paint hose for low pressure, int. 6 mm, ext. 8 mm, lenght 7,5 mt., fitting 3/8"
		TBP861038	Coupled PE/PA paint hose for low pressure, int. 6 mm, ext. 8 mm, lenght 10 mt., fitting 3/8"
TBP861538		Coupled PE/PA paint hose for low pressure, int. 6 mm, ext. 8 mm, lenght 15 mt., fitting 3/8"	
TBP862038		Coupled PE/PA paint hose for low pressure, int. 6 mm, ext. 8 mm, lenght 20 mt., fitting 3/8"	

Filters

Picture	Code	Description
	70101	Easy out gun filter spray gun KS25. Black, 60 mesh. Made from high quality stainless steel wire mesh. Approx. 8.15 mm diameter, 110 mm long. Weight: Approx. 3.2 g
	70102	Easy out gun filter for spray gun KS25. Made from high quality stainless steel wire mesh. Approx. 8.15 mm diameter, 110 mm long. Weight: Approx. 2.3 g
	70301	Gun filter for spray gun SK90. Made from high quality stainless steel wire mesh. Green, 30 mesh. Approx. diameter: 8.9 mm. Approx. length: 102 mm. Weight: Approx. 9 g
	70302	Gun filter for spray gun SK90. Made from high quality stainless steel wire mesh. White, 60 mesh. Approx. diameter: 8.9 mm. Approx. length: 102 mm. Weight: Approx. 9 g
	70303	Gun filter for spray gun SK90. Made from high quality stainless steel wire mesh. Yellow, 100 mesh. Approx. diameter: 8.9 mm. Approx. length: 102 mm. Weight: Approx. 9 g

Filters

Picture	Code	Description
	70304	Filtro calcio pistola tipo WAGNER 150 mesh
	70304	Gun filter for spray gun SK90. Made from high quality stainless steel wire mesh. Red, 200 mesh. Approx. diameter: 8.9 mm. Approx. length: 102 mm. Weight: Approx. 9 g
	79096 (50 mesh) 79097 (80 mesh) 79098 (150 mesh) 79099 (295 mesh)	Airless paint spray gun filter for OPTIMA. Made from high quality stainless steel wire mesh (Green: 50 mesh - White: 80 mesh - Yellow: 150 mesh - Red: 295 mesh)
	77077 (60 mesh) 77078 (100mesh) 77079 (200 mesh)	Pre-nozzle filter with single stainless steel net (60 - 100 - 200 mesh)
	77077R (60mesh) 77078R (100 mesh) 77079R (200 mesh)	Spare stainless steel net (60 - 100 - 200 mesh)

Filters

Picture	Code	Description
	<p>77091 (60 mesh) 77092 (100 mesh) 77093 (200mesh)</p>	<p>Lamellar filter (white: 60 mesh - black: 100 mesh - yellow: 200 mesh)</p>
	70801	<p>Manifold / fluid outlet filter. Made from high quality stainless steel wire mesh. Approx. 26 mm diameter and 140 mm long. - 30 mesh</p>
	70802	<p>Manifold / fluid outlet filter. Made from high quality stainless steel wire mesh. Approx. 26 mm diameter and 140 mm long. - 60 mesh</p>
	70803	<p>Manifold / fluid outlet filter. Made from high quality stainless steel wire mesh. Approx. 26 mm diameter and 140 mm long. - 100 mesh</p>
	70804	<p>Manifold / fluid outlet filter. Made from high quality stainless steel wire mesh. Approx. 26 mm diameter and 140 mm long. - 200 mesh</p>

Filters

Picture	Code	Description
	70812	Manifold / Fluid outlet filter. Approx. 26 mm diameter and 72 mm long. - 30 mesh
	70813	Manifold / Fluid outlet filter. Approx. 26 mm diameter and 72 mm long. - 60 mesh
	70814	Manifold / Fluid outlet filter. Approx. 26 mm diameter and 72 mm long. - 100 mesh
	70815	Manifold / Fluid outlet filter. Approx. 26 mm diameter and 72 mm long. - 200 mesh
	794163 (30 mesh) 794163A (60 mesh) 794163B (100 mesh)	MINI-SF suction filter with 28x1,5 thread. Double stainless steel mesh screen 15 + 30 - 60 or 100 mesh. Diameter 55 mm, length 80 mm.

Filters

Picture	Code	Description
	<p>794163R (30 mesh) 794163RA (60 mesh) 794163RB (100 mesh)</p>	<p>Spare cartridge net for MINI-SF suction filter. Double stainless steel mesh screen of 15 + 30 - 60 or 100 mesh. Diameter 48 mm, length 55 mm.</p>
	<p>794164 (30 mesh) 794164A (60 mesh) 794164B (100 mesh)</p>	<p>MAXI-SF suction filter with 28x1,5 thread. Double stainless steel mesh screen of 15 + 30, 60 and 100 mesh. Diameter 100 mm, length 100 mm.</p>
	<p>794164R (30 mesh) 794164RA (60 mesh) 794164RB (100 mesh)</p>	<p>Spare cartridge net for MINI-SF suction filter. Double stainless steel mesh screen of 15 + 30, 60 and 100 mesh. Diameter 98 mm, length 96 mm.</p>
	<p>799387A (1/2") 799387B (15x1,5)</p>	<p>Suction bell for disc filter (30 - 50 and 100 mesh). Available 1/2" and 15x1,5 thread.</p>
	<p>76761 (30 mesh) 76762 (50 mesh) 76763 (100 mesh)</p>	<p>Disc filter for suction bell. Diameter 87 mm. Available 30 - 50 - 100 mesh</p>

Filters

Picture	Code	Description
	FFL4395	Inline fluid filter in PVC for low pressure (max. 60 bar)
	FFL4396	Inline fluid filter in aluminium for low pressure (max. 60 bar)
	FFH5405	Inline fluid filter in aluminium for high pressure (max. 250 bar)
	FFH5406	Inline fluid filter in stainless steel for high pressure (max. 500 bar)

Tips and nozzles

Picture	Code	Description
	NZF001	Airless standard fixed nozzle (various sizes)
	NZA247	Airless adjustable nozzle (various sizes)
	TPN567	Airless standard tip nozzle (various sizes)
	TPF926	Airless fine-finish tip nozzle (various sizes)
	OPT001	Tip for OPTIMA 2000 spray gun (various sizes)
	SAG491	Tip for MK MIX spray gun (various sizes)

Suction pipes

Picture	Code	Description
	A1237049A	Suction-and-recycle system for wall paint, fitting F36x2 straight
	A1237049B	Suction-and-recycle system for wall paint, fitting F36x2 90°
	A1237049C	Suction-and-recycle system for wall paint, fitting F3/4" straight
	A1237049D	Suction-and-recycle system for wall paint, fitting F3/4" 90°
	A1237049E	Suction-and-recycle system for wall paint, fitting F1/2" straight
	A1237049F	Suction-and-recycle system for wall paint, fitting F1/2" 90°
	A0197050A	Suction-and-recycle system for paint, fitting F36x2 straight
	A0197050B	Suction-and-recycle system for paint, fitting F36x2 90°
	A0197050C	Suction-and-recycle system for paint, fitting F3/4" straight
	A0197050D	Suction-and-recycle system for paint, fitting F3/4" 90°
	A0197050E	Suction-and-recycle system for paint, fitting F1/2" straight
	A0197050F	Suction-and-recycle system for paint, fitting F1/2" 90°

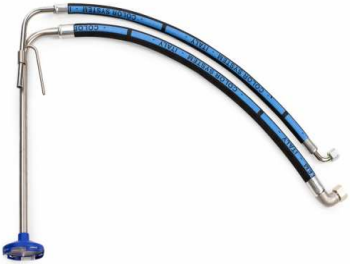

Suction pipes

Picture	Code	Description
	A0197005A	Suction-and-recycle system for paint in low pressure (rilsan pipe), fitting F3/4" straight
	A0197005B	Suction-and-recycle system for paint in low pressure (rilsan pipe), fitting F3/4" 90°
	A0197005C	Suction-and-recycle system for paint in low pressure (rilsan pipe), fitting F1/2" straight
	A0197005D	Suction-and-recycle system for paint in low pressure (rilsan pipe), fitting F1/2" 90°

Gravity hoppers

Picture

Code

Description



A4027013B

Black 6-liter gravity hopper, available thread 36x2 and 22x3



A1237005W

White 6-liter gravity hopper, available thread 36x2





A1237005W

35-liter gravity hopper, internally zinc plated, externally powder coated, available thread 36x2

Taps

Picture	Code	Description
	LPV14FF	Ball valve for low pressure. Thread FF1/4". Max. pressure 10 bar
	LPV38FF	Ball valve for low pressure. Thread FF3/8". Max. pressure 10 bar
	HPV1414FP	Ball valve for high pressure. Thread FF1/4". Max. pressure 500 bar
	HPV1414FX	Stainless-steel ball valve for high pressure. Thread FF1/4". Max. pressure 500 bar
	HPV1420MS	Ball valve for high pressure. Fittings M1/4" - M20x2. Max. pressure 500 bar
	HPV1420MX	Stainless steel ball valve for high pressure. Fittings M1/4" - M20x2. Max. pressure 500 bar
	HPV1414FG	Ball valve for high pressure. Thread FF1/4". Max. pressure 500 bar
	HPV1414FY	Stainless-steel ball valve for high pressure. Thread FF1/4". Max. pressure 500 bar
	HPV3838FG	Ball valve for high pressure. Thread FF3/8". Max. pressure 400 bar
	HPV3838FY	Stainless-steel ball valve for high pressure. Thread FF3/8". Max. pressure 400 bar
	HPV1420MB	Ball valve for high pressure. Fittings M1/4" - M20x2. Max. pressure 500 bar
	HPV1420MY	Stainless steel ball valve for high pressure. Fittings M1/4" - M20x2. Max. pressure 500 bar
	HPV3820MB	Ball valve for high pressure. Fittings M3/8" - M20x2. Max. pressure 400 bar
	HPV3820MY	Stainless steel ball valve for high pressure. Fittings M3/8" - M20x2. Max. pressure 400 bar

Taps

Picture	Code	Description
	HPV3W14F	Three-way ball valve for high pressure. Thread FFF1/4". Max. pressure 400 bar
	HPV3W38F	Three-way ball valve for high pressure. Thread FFF3/8". Max. pressure 400 bar
	RNG1414FX	Stainless steel needle valve for high pressure. Thread FF1/4". Max. pressure 400 bar

Nipples & fittings

Picture	Code	Description
	NAP1414	Nipple MM 1/4"
	NAP3838	Nipple MM 3/8"
	NAP1212	Nipple MM 1/2"
	NAP3434	Nipple MM 3/4"
	NAP0101	Nipple MM 1"
	NAP3814	Nipple MM 3/8" - 1/4"
	NAP1214	Nipple MM 1/2" - 1/4"
	NAP1238	Nipple MM 1/2" - 3/8"
	NAP3414	Nipple MM 3/4" - 1/4"
	NAP3438	Nipple MM 3/4" - 3/8"
	NAP3412	Nipple MM 3/4" - 1/2"
	NAP0138	Nipple MM 1" - 3/8"
	NAP0112	Nipple MM 1" - 1/2"
	NAP0134	Nipple MM 1" - 3/4"
	NAP1515	Nipple MM 16x1,5
	NAP1514	Nipple MM 16x1,5 - 1/4"
	NAP1538	Nipple MM 16x1,5 - 3/8"
	NAP1420	Nipple MM 1/4" - 20x2

Nipples & fittings

Picture	Code	Description
	NAX1414	Nipple MM 1/4" in stainless steel
	NAX1514	Nipple MM 16x1,5 - 1/4" in stainless steel
	NAX3814	Nipple MM 3/8" - 1/4" in stainless steel
	NAX1515	Nipple MM 16x1,5 in stainless steel
	NAX3838	Nipple MM 3/8" in stainless steel
	NAX1212	Nipple MM 1/2" in stainless steel
	NAX1420	Nipple MM 1/4" - 20x2 in stainless steel
	NAX1412	Nipple MM 1/4" - 1/2" in stainless steel
	NAX1238	Nipple MM 1/2" - 3/8" in stainless steel
	NAX3434	Nipple MM 3/4" in stainless steel
	NAX0101	Nipple MM 1" in stainless steel
	A901414	Adapter 90° M-FG 1/4"
	A903838	Adapter 90° M-FG 3/8"
	A901212	Adapter 90° M-FG 1/2"
	A903434	Adapter 90° M-FG 3/4"

Nipples & fittings

Picture	Code	Description
	ADT1414	Adapter M-FG 1/4"
	ADT3838	Adapter M-FG 3/8"
	ADT1212	Adapter M-FG 1/2"
	ADT3434	Adapter M-FG 3/4"
	ADT0101	Adapter M-FG 1"
	ADT1515	Adapter M-FG 16x1,5
	ADT1415	Adapter M 1/4" - FG 16x1,5
	ADT3815	Adapter M 3/8" - FG 16x1,5
	ADT1514	Adapter M 16x1,5 - FG 1/4"
	ADT1538	Adapter M 16x1,5 - FG 3/8"
	ADT1438	Adapter M 1/4" - FG 3/8"
	ADT3814	Adapter M 3/8" - FG 1/4"
	ADT0136	Adapter M 1" - FG 36x2
	ADX1414	Adapter M-FG 1/4" in stainless steel
	ADX3838	Adapter M-FG 3/8" in stainless steel
	ADX1515	Adapter M-FG 16x1,5 in stainless steel
	ADX1212	Adapter M-FG 1/2" in stainless steel
	ADX1415	Adapter M 1/4" - FG 16x1,5 in stainless steel
	ADX1438	Adapter M 1/4" - FG 3/8" in stainless steel
	ADX1514	Adapter M 16x1,5 - FG 1/4" in stainless steel
	ADX3814	Adapter M 3/8" - FG 1/4" in stainless steel

Accessories

Picture	Code	Description
	SPA111678	Adapter for airless spray guns 11/16" to 7/8"
	SPA781116	Adapter for airless spray guns 7/8" to 11/16"
	NDL12XX	Needles for nozzle cleaning (12 units)
	C242001L	"L"-shaped connection for gravity hopper. Threads M 36x2 - FG 36x2
	C24200U	"U"-shaped connection for gravity hopper. Threads M 36x2 - FG 36x2

Accessories



Picture	Code	Description
	A4027110A	Tip guard - Thread 11/16"
	NUT1116ST	Retaining nut for "ST" airless nozzle
	MDG1204C	Compensator & pressure gauge unit for airless diaphragm sprayers. Fittings 1/4"
	PRG7304H	Pressure gauge for high pressure (max. 400 bar)
	PRG7108L	Pressure gauge for low pressure (max. 10 bar)

Accessories

Picture	Code	Description
	STM4601A	Static mixer for bi-component products (inlet fittings: "A" component, "B" component, washing hose). Mixing spire in stainless steel. Total length: 40 cm
	STM4601B	Static mixer for bi-component products (inlet fittings: "A" component, "B" component, washing hose). Mixing spire in stainless steel. Total length: 60 cm
	FLX2301	Holder for embedded Wagner-type gun filter. Thread M-FG 1/4"
	FLX2302	Holder for embedded Wagner-type gun filter. Thread M 3/8" - FG 1/4"
	FLY2301	Holder for lamellar and pre-nozzle filter. Thread M-F 1/4"
	FLY2302	Holder for lamellar and pre-nozzle filter. Thread M 1/4" - F 3/8"
	A4037031A	Extension pole for airless spray gun. Length: 30 cm
	A4037031B	Extension pole for airless spray gun. Length: 50 cm
	A4037031C	Extension pole for airless spray gun. Length: 100 cm
	A4037031D	Extension pole for airless spray gun. Length: 200 cm



Accessories

Picture	Code	Description
	SW4037031A	Extension pole for airless spray gun with swivel. Length: 60 cm
	SW4037031B	Extension pole for airless spray gun with swivel. Length: 90 cm
	AFR9801	Airless-powered roller. Length: 150 cm
	ADC916A	Swivel for extension pole. Thread 1 1/16"
	ADC916B	Swivel for extension pole. Thread 7/8"

Spare parts

Picture	Code	Description
	4027251	Pressure compensator for airless diaphragm sprayer. Max. pressure 300 bar. Thread: F 28x1,5
	RSP9801	Replacement roll for airless roller
	A1097109	FRL group. Fitting 1/4"
	A1097104	FRL group. Fitting 3/8"
	A0197046	Complete diaphragm for SINAER sprayers mod. EXPORT 7000, EXPORT 10000, SC 7000, SC 10000.
	A0197046B	Complete diaphragm for SINAER sprayers mod. NEW 4500 and SC 4500

Spare parts

Picture	Code	Description
	93005	Eight-hole preformed diaphragm for air-assisted low pressure sprayers SINAER mod. MM 101 and DM 2000 S
	FVA7047X	Tungstene-carbide poppet for airless suction valve
	A0197047	Pressure regulator for diaphragm airless sprayer
	K1528364	Pressure regulator for low pressure air assisted sprayer

Spare parts

Picture	Code	Description
	SSG7601	MAXI sieve filter support in aluminium
	SSG7602	MINI sieve filter support in aluminium
	A0197045A	Suction valve for diaphragm airless sprayers SINAER mod. NEW 4500 and SC 4500 (short type)
	A0197045	Suction valve for diaphragm airless sprayers SINAER mod. NEW 4500 and SC 4500 (standard type)

Spare parts

Picture	Code	Description
	A0197051	Pressure retaining valve for diaphragm airless sprayers SINAER
	VSG9901H	Relief valve for diaphragm airless sprayers
	251827	Piston rod 18/25 x 392 mm (for piston sprayer SINAER mod. S 30:1 TX) in stainless steel
	103028X	Piston rod 22/30 x 392 mm (for piston sprayers SINAER mod. S 12:1 TN, S 20:1 TN, S 32:1 TN, S 50: 1 TN, SPRAY FORCE ONE 3.1-E, SPRAY FORCE ONE 3.1-P)
	123005XL	Piston rod 28/40 x 392 mm (for piston sprayers SINAER mod. SPRAY FORCE ONE 5.5-E, SPRAY FORCE ONE 5.5-P)
	123006XL	Piston rod 35/50 x 392 mm (for piston sprayers SINAER mod. SPRAY FORCE ONE 8.9-E, SPRAY FORCE ONE 8.9-P)

Spare parts

Picture	Code	Description
	SLP1825	Seal pack for 18/25 piston rod in leather and PTFE
	SLP2230	Seal pack for 22/30 piston rod in leather and PTFE
	SLP2840	Seal pack for 28/40 piston rod in leather and PTFE
	SLP3550	Seal pack for 35/50 piston rod in leather and PTFE
	KT071	Spare kit for M71 (needle, cap, nozzle)
	KT077	Spare kit for M77 (needle, cap, nozzle)
	KT0100	Spare kit for M100 (needle, cap, nozzle)
	KT591	Spare kit for K591 (needle, cap, nozzle)
	HD045AL	Head for NEW 4500 - SC 4500 in aluminium
	HD045ST	Head for NEW 4500 - SC 4500 in stainless steel
	HD100AL	Head for EXPORT 7000 - EXPORT 10000 - SC 7000 - SC 10000 in aluminium
	HD100ST	Head for EXPORT 7000 - EXPORT 10000 - SC 7000 - SC 10000 in stainless steel



Notes



SPRAY EQUIPMENT SINCE 1980
MACCHINE PER VERNICIATURA DAL 1980
PROUDLY MADE IN **ITALY**



Watch us on



SINAER® by MEDIA SPRAY s.r.l. - Via Roma 130/D - 06030 Giano dell'Umbria (PG) ITALY
Tel. +39 0742 846376 - Fax +39 0742 840237 - E-mail: info@sinaer.eu

www.sinaer.eu